



Model 2970H
Leveling System
Operator Manual
(D-082301DJC01B)

SERIAL NUMBER LOCATION



**Serial Number
Location**

Write the serial number and the model number of the Leveling System on the lines provided. If needed, give these numbers to your dealer when you need parts or information for your machine.

SERIAL NUMBER

MODEL NUMBER

TABLE OF CONTENTS



2000 Series Operator's Manual Model 2970 Leveling Systems

SERIAL NUMBER LOCATION.....	1
TABLE OF CONTENTS.....	2
WARRANTY POLICY.....	3
SAFETY	5
SAFETY ALERT SYMBOL.....	5
OPERATION SAFETY	6
HYDRAULIC SAFETY.....	6
SERVICING AND MAINTENANCE SAFETY	6
HIGHWAY OPERATION AND TRANSPORT SAFETY.....	7
SAFETY LABELS.....	7
SAFETY LABEL SPECIFICATIONS	9
OPERATION, SETUP, AND MAINTENANCE	10
ELECTRICAL OPERATION	10
ELECTRICAL SETTINGS	11
LIMIT SWITCHES.....	11
LEVELING CONTROLLERS.....	12
MECHANICAL ADJUSTMENTS	13
MODEL 2970 TREAD WIDTH – Slope Restrictions.....	13
TIRE SELECTION – Slope Restrictions.....	13
HEADER AND COMBINE CONNECTION.....	14
REAR AXLE WEIGHTING.....	14
REAR AXLE EXTENSION POSITIONING.....	15
REAR AXLE TOE IN.....	15
TRANSITION DRIVE CHAIN.....	15
LADDER.....	17
GENERAL SHIELDING.....	17
HYDRAULIC SETTINGS.....	17
HYDRAULIC HOSES.....	18
HYDRAULIC CYLINDERS	18
GREASE LOCATIONS.....	18
GREASE LOCATIONS (CONTINUED)	19
GREASE LOCATIONS (CONTINUED)	21
FASTENERS.....	21
TIRE INFLATION	24
SCHEMATICS.....	25

WARRANTY POLICY

Hillco Leveling System Warranty

Hillco warrants the Hillco Leveling System to the original retail purchaser, or authorized transferee, to be free from defects in material or workmanship for a period of twelve (12) months following the warranty start date. Hillco additionally agrees to provide a one year warranty to the dealer and retail customer for John Deere parts or components that are modified or affected by the conversion, provided that those defects are attributable to the design or manufacture of the Hillco Leveling System. Hillco's obligation under this warranty shall be limited to the repair or replacement, at Hillco's option, of any product or part, which proves to be defective. All other costs, including labor and travel expense, are not the responsibility of Hillco. All warranty service must be provided by Hillco or an authorized Hillco Leveling System dealer using only authorized Hillco parts.

Warranty Procedure

The warranty start date shall be the date of sale of the Hillco Leveling System to the original retail purchaser or the first day of July preceding the first use season, whichever is earlier, or as otherwise authorized in writing by Hillco.

The Hillco Leveling System Warranty Registration Card must be returned to Hillco within 30 days of sale of such unit to the original retail purchaser. Warranty may be transferred to a second retail purchaser, during the warranty period, provided that an authorized Hillco Leveling System dealer completes a John Deere warranty transfer form and a copy is sent to Hillco.

Warranty claims must be submitted to Hillco during the warranty period and must include the combine and Hillco Leveling System serial numbers. Hillco reserves the right to either inspect the product at the original retail purchaser's location, or the authorized Hillco dealer's location; or require it to be returned to Hillco, F.O.B. Hillco, for inspection.

Exclusions to General Warranty

This warranty does not cover:

- 1) Hillco Leveling Systems installed by anyone other than an authorized Hillco Leveling System dealer, Hillco or other parties specifically authorized by Hillco.
- 2) Warranty claims directly resulting from improper installation.
- 3) Any product damaged by accident, abuse, misuse, or negligence after shipment from Hillco.
- 4) Any product altered or modified unless such alterations or modifications are specifically authorized by Hillco.

Limitation of Liability

Hillco makes no express warranties other than those, which are specifically described herein. Any description of the goods sold hereunder, including any reference to buyer's specifications and any descriptions in circulars and other written material published by Hillco is for the sole purpose of identifying such goods and shall not create an express warranty that the goods shall conform to such description.

THIS WARRANTY IS EXPRESSLY IN LIEU OF ALL OTHER WARRANTIES EXPRESSED OR IMPLIED. There are no implied warranties of merchantability or fitness for a particular purpose. This warranty states Hillco's entire and exclusive liability and buyer's exclusive remedy for any claim for damages in connection with the sale or furnishing of Hillco products, their design, suitability for use, installation or operation, or for any claimed defects herein. **HILLCO WILL IN NO EVENT BE LIABLE FOR ANY INCIDENTAL OR CONSEQUENTIAL DAMAGES WHATSOEVER, NOR FOR ANY SUM IN EXCESS OF THE PRICE RECEIVED FOR THE GOODS FOR WHICH LIABILITY IS CLAIMED.**

No representative of Hillco nor any dealer associated with Hillco has the authority to change the items of this warranty in any manner whatsoever, and no assistance to purchaser by Hillco in the repair or operation of any Hillco product shall constitute a waiver of the conditions of this warranty, nor shall such assistance extend or revive it.

INTRODUCTION

Thank you for choosing the Hillco 2000 Series Leveling System to compliment your farming operation. This product has been designed and manufactured to meet the needs of a discriminating buyer for increasing the performance of a combine.

Safe, efficient and trouble free use of your Hillco 2000 Series Leveling System requires that you and anyone else who will be operating or maintaining the leveling system, read and understand the safety, operation, and maintenance information contained in the Operator's Manual.

If extra copies of the operator's manual are needed, contact Hillco at 1-800-937-2461 and ask for document D-082301DJC01 REV2.

HILLCO MODEL 2970 LEVELING SYSTEM



This manual covers the Hillco 2000 Series Model 2970 Leveling System built by Hillco. Use the Table of Contents as a guide when searching for specific information.

Keep this manual handy for frequent reference and to pass on to new operators or owners. Call your Hillco dealer or Hillco if you need assistance or information at 1-800-937-2461.

OPERATOR ORIENTATION – The directions left, right, front, and rear, as mentioned throughout this manual, are as seen from the combine operator's seat and facing in the direction of forward travel.

SAFETY

SAFETY ALERT SYMBOL

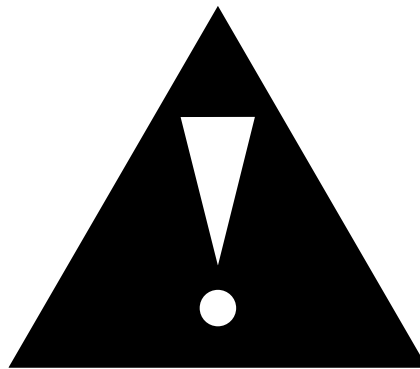

This Safety Alert symbol means
ATTENTION! BECOME ALERT! YOUR SAFETY IS INVOLVED!

The Safety Alert symbol identifies important safety messages on the Hillco 2000 Series Leveling System and in the manual. When you see this symbol, be alert to the possibility of personal injury or death. Follow the instructions in the safety message.

SIGNAL WORDS

Note the use of the signal words **DANGER**, **WARNING**, and **CAUTION** with the safety messages. The appropriate signal word for each message has been selected using the following guidelines:

DANGER - An immediate and specific hazard which WILL result in severe personal injury or death if the proper precautions are not taken.

WARNING - A specific hazard or unsafe practice which COULD result in severe personal injury or death if proper precautions are not taken.

CAUTION - Unsafe practices which COULD result in personal injury if proper practices are not taken, or as a reminder of good safety practices.

OPERATION SAFETY

1. Read and understand the Operator's Manual and all safety labels before operating the leveling system.
2. Make sure that all controls are in the manual position before starting the combine.
3. Clear the area of all bystanders, especially children, before starting the leveling system and during operation.
4. Make sure all safety shields are in place before operating the combine. Never operate the machine with the shields removed.
5. Keep hands, feet, hair and clothing away from all moving and/or rotating parts.
6. Stay seated in the cab during operation.
7. Operate controls only when sitting in the seat of the combine.
8. To avoid engine damage, do not run the machine for extended periods of time when it is in the leveled over position.
9. Always travel at a safe speed. Use caution when making turns or traversing ditches.
10. There are restrictions as to tread width and tire selection. Refer to page 13 for important information on these restrictions.
11. The use of after-market grain tank extensions is prohibited from use on combines equipped with the Model 2970 leveling system.

HYDRAULIC SAFETY

1. Do not search for high-pressure hydraulic leaks without hand and face protection. A tiny, almost invisible leak can penetrate skin, thereby requiring immediate medical attention. Gangrene may set in, in as few as 3 hours!
2. Use cardboard or wood to detect leaks – never your hands!
3. Double check that all is clear before operating hydraulics.
4. Maintain proper hydraulic fluid levels.
5. Ensure all fittings and hoses are in good repair.
6. Do not make any repairs to the leveling system hydraulic system including: cylinders, valves, hydraulic hoses, adapters, pumps, manifolds, or reservoirs without first contacting you authorized Hillco dealer. These hydraulic components stabilize the chassis of the combine. Improper repair or replacement of these components could lead to uncontrolled leveling of the combine's chassis.



SERVICING AND MAINTENANCE SAFETY

1. Review the Operator's Manual and all safety items before servicing or maintaining the leveling system.
2. Place the Auto/Off/Manual leveling switch in the "Off" position, stop the combine engine, wait for any moving parts to stop, block the tires, the header, and the cylinder areas before servicing, repairing, adjusting, or maintaining the leveling system.

3. Hydraulic oil is under pressure. Use caution when dealing with the hydraulic system.
4. Keep hands, feet clothing and hair away from all moving and/or rotating parts.
5. Clear the area of bystanders, especially children, when carrying out any maintenance, repairs or making any adjustments.

HIGHWAY OPERATION AND TRANSPORT SAFETY

1. Check with local authorities regarding combine transport on public roads. Obey all applicable regulations and laws.
2. Check clearance elevations and widths of combine for travel near power lines, bridges, trees, etc.
3. Make sure the Auto/Off/Manual leveling toggle switch is in the “Off” position for all transport and highway travel situations.
4. Always travel at a safe speed. Use caution when making corners or meeting traffic.

SAFETY LABELS

Familiarize yourself with the location of all safety labels. Read them carefully to understand the safe operation of your machine.

“Read Operator’s Manual” Symbol

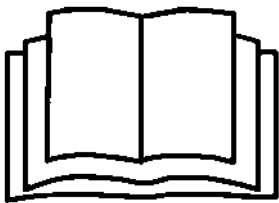

Decals, which display the “Read Operator’s Manual” symbol, are intended to direct the operator to the Operator’s Manual for further information regarding maintenance, adjustments and/or procedures for particular areas of the leveling system. When a decal displays this symbol refer to the Operator’s Manual for further instructions.

TO APPLY NEW OR REPLACEMENT LABELS:

1. Make sure the label area is smooth by removing any debris such as dirt or old labels.
2. Wash the area with soap and water and then dry it thoroughly.
3. After the area has completely dried, peel the backing off the safety label and place it onto the cleaned area.

4. Make sure all areas of the label have adhered to the machine by pressing down on the entire face of the label, including the corners.

SAFETY LABEL LOCATIONS

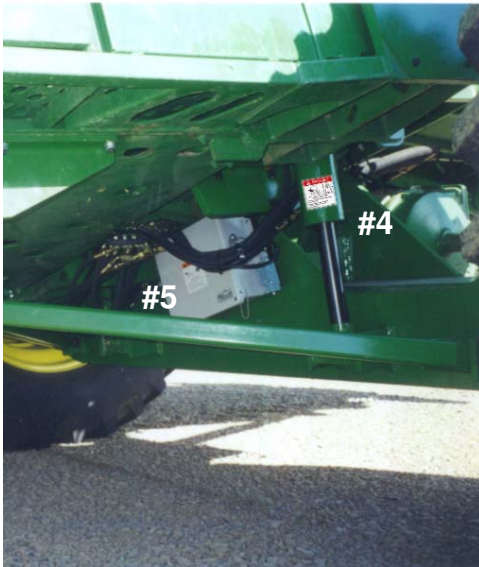
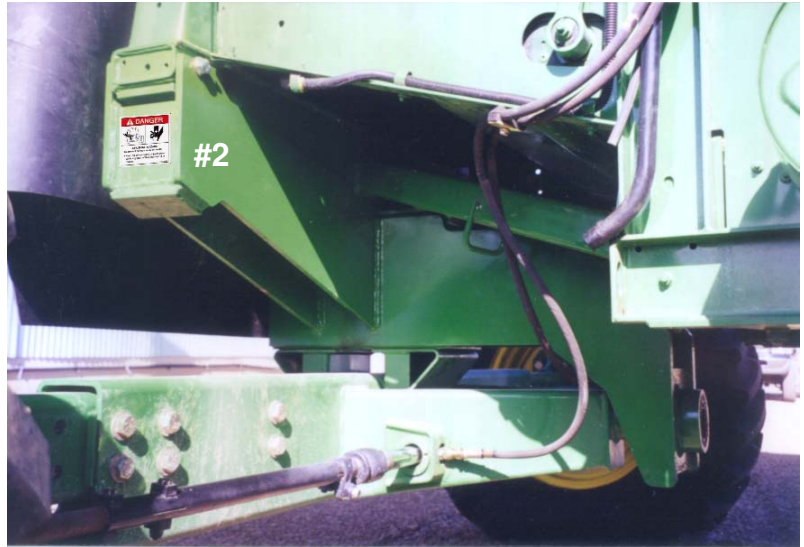

SAFETY LABEL SPECIFICATIONS

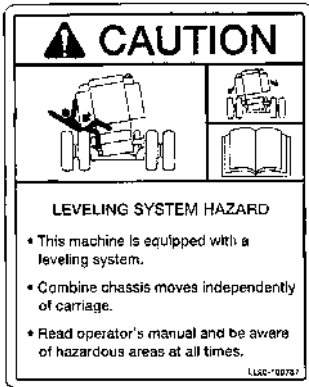

Label #1
Part number: LL20-100787
Locations: 2 (left and right side of combine above front tires)



Label #2
Part Number: LL20-100783
Locations: 6 (front and rear of undercarriage and each side of drop axle assembly)



Label #3
Part number: LL20-10784
Locations: 2 (left and right side of upper transition face plate)



Label #4
Part number: LL20-100788
Locations: 3 (main cylinders and above leveling manifold)



Label #5
Part number: LL20-100786
Locations: 1 (front of electrical box)

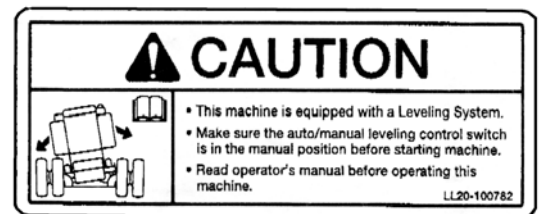

Label #6
Part number: LL20-100782
Locations: 1 (inside cab window beyond console)



These safety labels should be present and legible at all times. If new labels are needed, or you have any questions concerning safety,

Label #7
Part number: LL20-100785
Locations: 1 (ladder well)

OPERATION, SETUP, AND MAINTENANCE

ELECTRICAL OPERATION

LEVELING SYSTEM CONTROLS

MANUAL LEFT / RIGHT LEVELING SWITCH

LEVEL LEFT: Push the switch to the left.

LEVEL RIGHT: Push the switch to the right.

AUTO / OFF / MANUAL LEVELING SWITCH

AUTO: Push the Auto/Off/Manual leveling switch to the Auto position to select automatic leveling operation. The automatic leveling controllers monitor changes in slope and automatically keep the chassis of the combine level. The MANUAL LEFT / RIGHT leveling switch will override the automatic leveling controllers but when this switch is released the controllers will again automatically level the combine chassis.

MANUAL: Push the Auto/Off/Manual leveling switch to the Manual position to select manual leveling operation. With the switch in this position the Manual Left/Right leveling switch will level the combine left and right. When the switch is released the combine chassis will maintain the current chassis position.

HEADER TRIM SWITCH

The header trim switch is the four-position header control switch mounted in the combine's SR control lever. It is used to raise and lower the header as well as trim the header left and right.

TILT LEFT: Push the switch to the left to tilt the header counterclockwise.

TILT RIGHT: Push the switch to the right to tilt the header clockwise

MAXIMUM LEVEL LAMP

The leveling system is equipped with a maximum level warning lamp. This lamp indicates when the machine has reached its maximum leveling capability. Important tire and tread width restrictions apply to the use of combines equipped with the Model 2970 Leveling system that are intended for use on slopes exceeding the maximum leveling capability. See page 13 for important details of these restrictions.



ELECTRICAL SETTINGS

LIMIT SWITCHES

The leveling system is equipped with left and right level limit switches that disable the automatic leveling when the combine reaches its maximum leveling capability in either direction. These switches are preset by the installer at either the maximum leveling capability of the combine or in some cases at a lesser angle to provide for proper tire clearance. It is important to note that in the event of a limit switch failure the combine may continue to level to its maximum capability. Care should be taken to make sure tire clearances are adequate in the maximum level position to prevent damage to the tire or chassis in the event that a limit switch failure should occur. The operator should daily level the combine to its maximum level position, with the bulk tank empty, using the manual leveling switch to insure the limit switches are operational.

IMPORTANT: With certain tire selections mechanical cylinder stops can be purchased from Hillco to prevent damage to the combines side panels if limit switch failed or the leveling valve failure.

To set the limit switches, first park the combine on level ground and block the tires. Then raise the feeder spout and lock the feeder lift cylinder. Place the auto/off/manual-leveling switch in the off position. Lean the combine to the left to maximum level of the cylinders or to the maximum point that there is no sheet metal to tire interference. It may be a good practice to level a small distance, stop and check for clearance issues before continuing. Next, turn on the parking brake and shut down the machine. The limit switches are located on each side of the control box near the main pivot pin. Align the limit switch actuator

bracket so that it is aligned with the left limit switch. Adjust the left limit switch actuator bolt one turn past the point where you can hear the contacts on the limit switch snap. Repeat this process for the right limit switch.

LEVELING CONTROLLERS

FUNCTION

The Hillco Model 2970 Leveling System is equipped with a two speed leveling system with manual control and automatic with manual override control. The low and high speed leveling controllers, located in the control box, monitor changes in slope and correct the position of the combine's chassis using dual speed leveling. The "L" low speed controller maintains leveling accuracy to +/- 1-1/2 degrees by sending the leveling signal to the low speed leveling control valve on the manifold. The "H" high-speed controller energizes the high-speed leveling control cartridge valve on the manifold to add to the flow of the low speed leveling control valve when chassis positions exceeding +/- 4-1/2 degrees are reached.

CONTROLLER ADJUSTMENT

The leveling controllers are properly positioned when the combine returns to the level position in the automatic mode from both the left and the right. A 1-1/2 degree dead band each direction from level in the low speed controller will prevent the chassis from returning to absolute level. If the combine does not return to the same level point from each side and the chassis leans more one direction than the other, the primary adjustment is to rotate the entire control box using the two slotted holes in the control box mounting plate. To reset the controller angle first park the combine on level ground, raise the header, turn off the ignition, block the tires, and lock the feeder lift cylinder. Loosen the fastener on the side of the control box mounting plate you desire the combine to level towards and raise that side of the mounting plate and retighten the fastener. Again level the combine each direction and return it to level using the automatic mode. It is often helpful to level the combine at low idle during this process so that the leveling speed is reduced during adjustment. Repeat this process until the chassis returns to level from the left and right. The limit switches are mounted on the control box mounting plate and should be reset after leveling adjustments are made as indicated in the Limit Switch Adjustment section.

Individual Low and High Speed Adjustments – In the event the slotted holes in the control box mounting plate are not adequate to fully level the combine, both the low and high speed controllers inside the control box can be independently adjusted.

Individual Low Speed Adjustment - If the combine does not level evenly from both sides, and all of the adjustment has been used in the control box mounting plate as outlined above, follow these low speed adjustment steps. Park the combine on level ground, raise the header, turn off the ignition, block the tires, and lock the feeder lift cylinder. Open the control box and loosen the two lower mounting screws that mount the low speed controller into the control box. The bottom holes in the leveling controller are slotted to allow the controller to be rotated. Move the bottom of the controller in the direction you wish the combine to level. Once the controller has been moved and the mounting bolts retightened, level the combine to each side and returns to level using automatic leveling and again check for level. Repeat as necessary.

Individual High Speed Adjustment - High speed leveling is properly set if the combine shifts from high to low speed in approximately the same position from left and right. Because of the small trip angle

difference between high and low speed leveling and the high response speed, it may appear that during testing on level ground there is no noticeable shift from high to low speed. This is common if the controllers are adjusted properly. However, if the combine has a long defined period of low speed leveling from one direction and not from the other, the high-speed controller should be adjusted to balance the leveling response from both sides. To adjust the high-speed controller, park the combine on level ground, raise the header, turn off the ignition, block the tires, and lock the feeder lift cylinder. Open the control box and loosen the two lower mounting screws that mount the high-speed controller into the control box. The bottom holes in the leveling controller are slotted to allow the controller to be rotated. Move the bottom of the controller in the direction you wish the combine to level. Once the controller has been moved and the mountings bolts retightened, level the combine to each side and return to level using automatic leveling and again check for the shift point from high to low speed. If the shift points are equal the high-speed controller is properly adjusted.

Note: The 1 ½ degree low speed and 4 ½ degree high-speed trip angles are internally adjusted in the leveling controllers. These trip angles have been pre-adjusted for maximum performance by Hillco and should not be readjusted without first contacting Hillco for additional adjustment instructions.

MECHANICAL ADJUSTMENTS

WIDTH – Slope MODEL 2970 TREAD Restrictions



The Model 2970 Leveling System is designed around a main undercarriage length of 114.5” or 122.5”. The 114.5” undercarriage is designed for use with dual tire packages where 120-180” tread spacing is preferred for 30” rows. Use of the 114.5” undercarriage with duals will limit the leveling capability of the combine from 27% to 23%. The 122.5” undercarriage was designed to move the dual tires outward and allow for the maximum leveling capability of the combine or 27%. The final drives can be mounted directly to the 114.5” and 122.5” undercarriages. **The minimum allowable tread width for use on a Model 2970 leveling system is 145”.** **The 145” tread spacing is prohibited from use on slopes that exceed 27% or the maximum leveling capability of the combine.** Dual tires are required for combines intended for use on slopes greater than 27%.

On Model 2970 leveling systems the 145” tread width can be achieved by mounting the final drives directly to the undercarriage and dishing the stock combine single wheels inward on the 114.5” undercarriage. Check the tread width using a tape measure to insure your machine is not operating on less than the minimum 145” tread spacing.

TIRE SELECTION – Slope Restrictions

Model 2970 Single Tires – Combines equipped with the Model 2970 Leveling System may be equipped with 30.5L-32 single tires with a 16 ply rating, 35.5L-32 with a 12 ply rating, 800/65R32, or 68x50-32 HF3 with a 16 ply rating provided the combine is

operated at or below the 27% maximum leveling capability of the leveling system.
Use of these tire selections is prohibited on slopes greater than 27%.

Model 2970 Dual Tires for Slopes Less than 27% - Combines equipped with the Model 2970 Leveling System may be equipped with 20.8R-38 one star rating, and 18.4R-42 two star rating dual tires provided that the combine is operated at or below the 27% maximum leveling capability of the leveling system. **Use of these tire selections is prohibited on slopes greater than 27%.**

Model 2970 Dual Tires for Slopes Greater than 27%-Combines equipped with the Model 2970 Leveling System must be equipped with 24.5-32 10 ply rating or 20.8R-42 two star rating dual tires if the combine is intended for use on slopes exceeding 27% or the maximum leveling capability of the combine.

HEADER AND COMBINE CONNECTION

Refer to the John Deere Combine STS Operator's Manual for instructions on connecting the header to the combine.

Note: Hose lengths should have been lengthened to allow for maximum rotation of the header during the installation.

All John Deere headers require a HILLCO Header Kit to function properly during rotation of the transition.

REAR AXLE WEIGHTING

The HILLCO Model 2970 Leveling System is designed to transfer enough weight to the rear axle of the combine for proper balance that no additional weight is needed. If it is felt that additional weight is needed on the rear axle it can be accomplished by adding:

- 1) Calcium Chloride in Rear Tires
- 2) John Deere Rear Wheel Weights

Use caution when using individual turning brakes. Installation of a Hillco Leveling System transmits additional weight to the rear axle of the combine. Excessive braking to turn can damage your combine chassis.

The responsibility for making the final determination of appropriate rear axle weighting lies with the operator.

When first operating the Model 2970 Leveling System in hillside conditions, begin operation on gradual slopes and work up to more severe slopes only after you have determined that rear axle weighting is appropriate for downhill maneuvers. The first indication of insufficient rear axle weighting is sluggish or unresponsive steering while traveling down hill. This effect will worsen if the operator decelerates. Make sure rear axle weighting is sufficient for safe down hill maneuvers, under normal deceleration, in your most severe down hill conditions.

Use of grain tank extensions is strictly forbidden. Use of such extensions voids both the Hillco and John Deere new equipment warranties.

REAR AXLE EXTENSION POSITIONING

The rear axle on the combine is designed so that the axle extensions may be bolted in two different positions to adjust the rear height of the combine. The rear axle extension position may need to be adjusted after the correct tires and header are installed on the combine. The combine should sit level to two inches high in the rear. If it does not, then the axle extension position will have to be adjusted and the tire size may have to be changed. Consult your combine's operator's manual for more information on the proper stub axle position.

REAR AXLE TOE IN

If the rear tire and wheel size changed after the proper sized rear tires were installed the toe in should be checked. Consult your combine's operator's manual on the correct toe in for your tire and wheel size.

TRANSITION DRIVE CHAIN

Check to see that the transition drive chain is in proper alignment and has proper tension. Misalignment of these sprockets will cause premature wear of the sprockets and chain. Chain tension is maintained with the tensioner that is bolted to the left side of the transition. Tensioner adjustment can be found in the following paragraph.

CHAIN TENSIONER ADJUSTMENT INSTRUCTIONS

Step 1

Adjust the tensioner to the correct degree of tension by placing a wrench on the square portion of the tensioner body and a second wrench on the mounting bolt.

Step 2

Apply pressure to the tensioner body in the appropriate direction until the chain is properly tensioned. (See Figure 1) Note that the tensioner is designed to deflect up to 30 degrees either side of its normal position.

Step 3

While holding the tensioner body in position, torque the mounting bolt to 60 lb ft.

Step 4

Before starting the drive, check the nuts on the idler bolt for tightness.

Step 5

After the drive has been started, visually inspect the tensioner for alignment and proper tensioning.

Figure 1

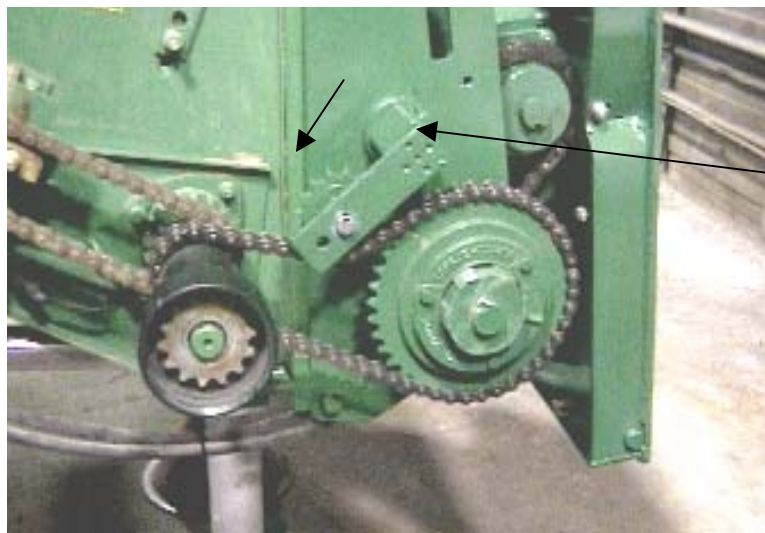

Apply pressure here
in the direction
denoted by second
arrow.

TRANSITION SLIP CLUTCH

The transition slip clutch is preset at the factory so that damage will not occur to any of the transition drive components, and shouldn't require any adjustment for the first harvest or until the clutch is slipped excessively. The slip clutch should be adjusted using the following steps if adjustment is necessary.

Remove the three 3/8 tension bolts located on the outside of the slip clutch hub. Loosen the setscrew located in the middle of the hub; it should be set in one of the valleys. Back the hub off until it spins freely and then retighten hand tight. Locate the closest valley to the set screw and starting from that valley loosen the hub 3 valleys counting the valley that was

closest to the set screw when it was hand tight. Retighten the setscrew making sure that it is set in the bottom of the valley and then reinstall the three 3/8 tension bolts making sure they are tightened flush with the head of the bolt.

If the slip clutch slips extensively because of bad harvest conditions then it should be readjusted to take up any slack in the worn discs. If the discs in the slip clutch need replacing, then the centering bushing should be replaced with them. **Setting the slip clutch too tight by the operator will VOID the warranty on the transition drive components.**

LADDER

Run the ladder platform in the 45-degree position to maintain maximum header-to-driveline clearance and tire clearance. The bottom bi-fold section of the ladder is held in the retracted position with two gas-charged struts. If the ladder doesn't retract properly then check the tightness of all the bolts in the hinge positions and make sure that they are just snug. If all of the bolts appear to be at the correct tightness and the ladder still won't stay retracted then it is possible that one of the gas-charged struts has failed.

GENERAL SHIELDING

Before operating the combine all shields must be in place and be in working condition.

Shield to tire clearance needs to be checked once the correct tires are installed on the combine. Check to see if the clearance is correct by having someone watch the tire and shields as the operator leans the combine to the far right and far left. Some tire selections require limit switches to be set slightly early to allow enough tire clearance between the left and right front side panels.

HYDRAULIC SETTINGS

Refer to the Hydraulic Safety section located on page 6 for precautions regarding the hydraulic system.

The Model 2970 Leveling System uses an auxiliary pump and four station manifold for its hydraulic requirements. The following hydraulic schematic at the end of this manual covers the leveling system circuitry. Consult your combines operator's manual or contact your John Deere dealer for diagnostics and maintenance regarding the remainder of the hydraulic system.

IMPORTANT:



All adjustments on the hydraulic system are preset at the factory for optimal leveling and header trim performance. **DO NOT MAKE ANY ADJUSTMENTS TO THESE SETTINGS WITHOUT FIRST CONTACTING YOUR AUTHORIZED HILLCO DEALER.**

HYDRAULIC HOSES

Inspect the hydraulic system for leaks, damaged hoses, improper routing, and loose fittings.

Hydraulic hoses that are not routed correctly could become worn from working against abrasive edges or moving parts. If abrasions or holes do occur, the hydraulic hoses can only be repaired by replacement. **Do not attempt repairs with tape or cements.** High pressure will burst such repairs and cause system failure and possible injury.

Hydraulic Hose Connections – When tightening loose hoses on the cylinders, pump, etc., always use one wrench to keep the hose from twisting and another wrench to tighten the union. Excessive twisting will shorten hose life and allow the fitting to loosen during operation. Do not over-tighten fittings or adapters.

Refer to the John Deere Combine's Operators Manual for information regarding hydraulic oil, check intervals, and reservoir fluid levels. High speed leveling, low speed leveling and header trim speeds are preset at the factory. If different speeds are desired please contact your Hillco dealer.

HYDRAULIC CYLINDERS

IMPORTANT: Each leveling cylinder is equipped with a safety valve that is in place to prevent unintentional leak down of the cylinder. These safety valves are preset at the factory, and should not be adjusted.



DANGER: Do not make any repairs to the cylinders, disconnect valves or any hoses connected to the cylinders, counterbalance valves, bulkhead mount or manifold without first contacting your authorized Hillco dealer. These hydraulic components stabilize the chassis of the combine. Improper repair or replacement of these components could lead to uncontrolled leveling of the combine's chassis.

Hydraulic schematics for the John Deere Model 2970 Leveling System are on page 26 at the end of this manual.

GREASE LOCATIONS

Use John Deere 251H EP grease or equivalent NLGI No. 2 Multi-Purpose Lithium Grease.



Slave Cylinder
🕒 50 hrs.
2 Zerks



Rear Axle Pivot
Grease Every 10 hrs
Of Operation

GREASE LOCATIONS (CONTINUED)

GREASE BULKHEAD:
Grease All Five Zerks
Every 10 hrs. of Operation

These Zerks Lubricate the Main
Pivot Pin, Master Cylinder Rod
and Base End, and the Base
End of the Leveling Cylinders

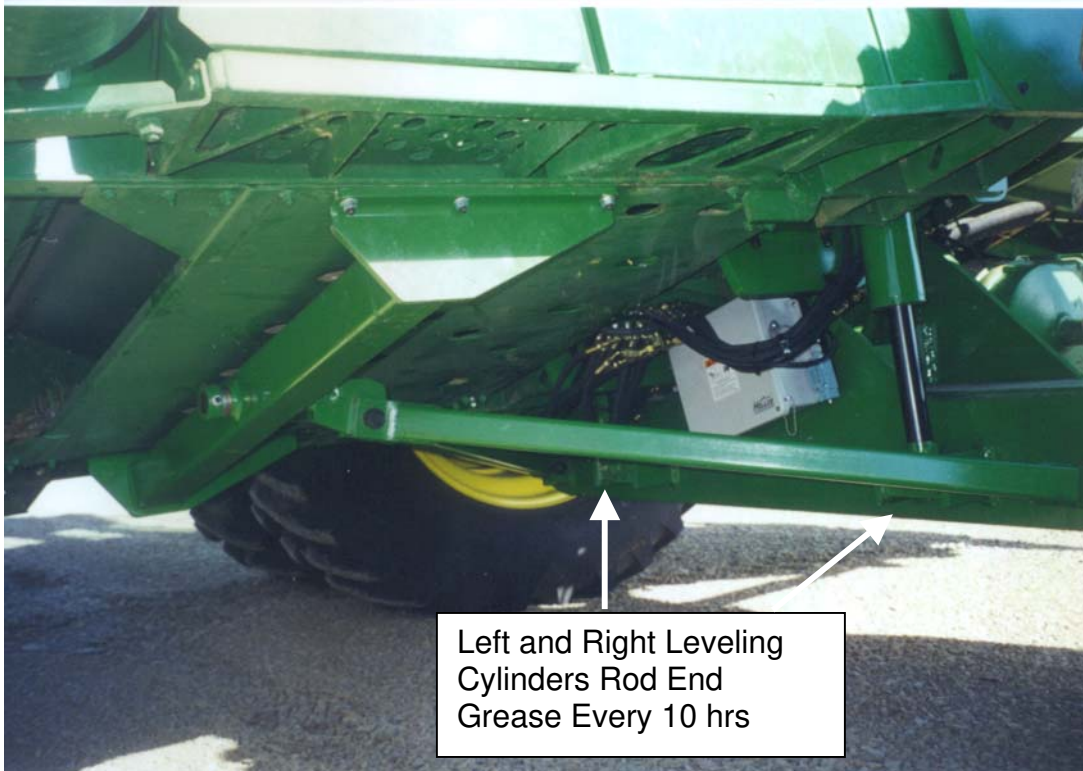

Left and Right Leveling
Cylinders Rod End
Grease Every 10 hrs

GREASE LOCATIONS (CONTINUED)

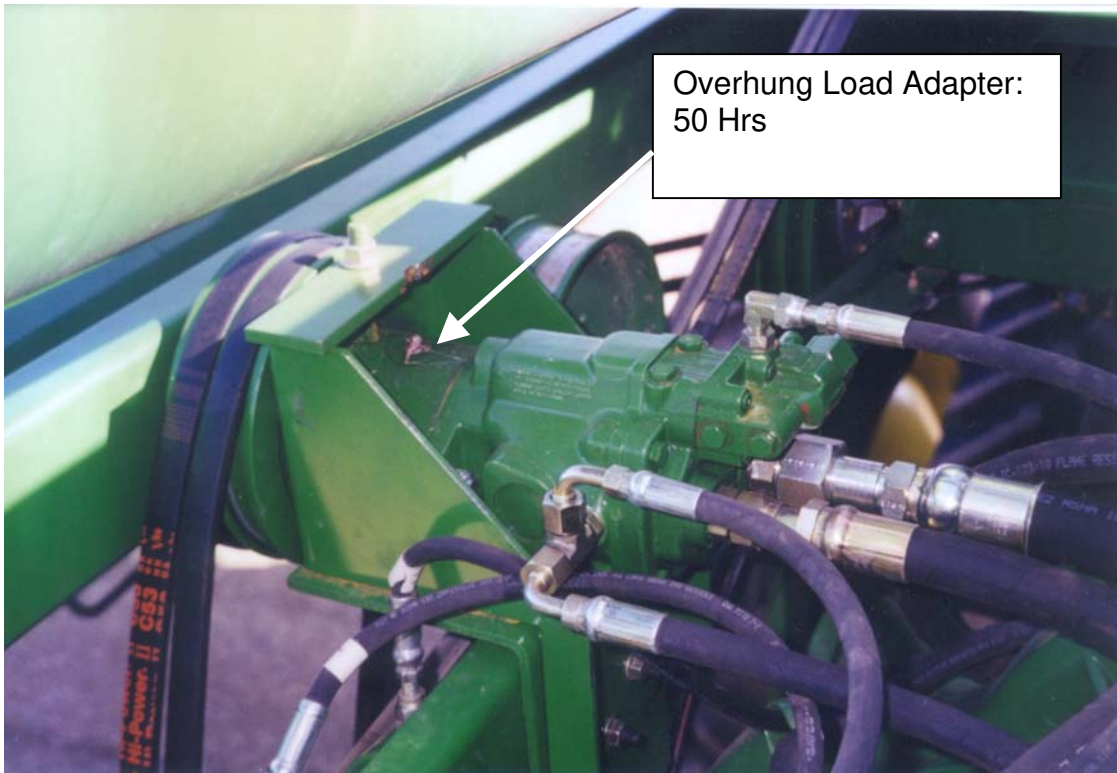

FASTENERS

Check Bolt Tightness











- After the first 10 hours of operation
- Every season

The following bolts are torqued to special specifications because of the application in which they are used.

Transmission Mount Bolts:	John Deere Torque specifications
Final Drive Housing Bolts:	John Deere Torque specifications
Drive Wheel Hub Bolts:	John Deere Torque specifications
Steering Wheel Hub Bolts:	John Deere Torque specifications
Rear Axle Extension Bolts:	John Deere Torque Specifications
Unloading Auger Drive Shaft Locknut::	John Deere Torque Specifications

IMPORTANT: Consult your John Deere 9650 & 9750 STS operator's manual to verify that correct bolts and spacers are used for the wheel application.

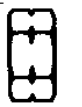
Unified Inch Bolt and Cap Screw Torque Values
(for Hillco 2000 Series Leveling Systems Only)

SAE Grade and Head Markings	1 or 2 ^b	5	5.1	5.2	8	8.2
	NO MARK 					
SAE Grade and Nut Markings	2	5		8		
	NO MARK 					

Size	Grade 1 ^a				Grade 2 ^b				Grade 5, 5.1, or 5.2				Grade 8 or 8.2			
	Lubricated ^c		Dry ^d		Lubricated ^d		Dry ^d		Lubricated ^d		Dry ^d		Lubricated ^d		Dry ^d	
	N•m	lb-ft	N•m	lb-ft	N•m	lb-ft	N•m	lb-ft	N•m	lb-ft	N•m	lb-ft	N•m	lb-ft	N•m	lb-ft
1/4	3.7	2.8	4.7	3.5	6	4.5	7.5	5.5	9.5	7	12	9	13.5	10	17	12.5
5/16	7.7	5.5	10	7	12	9	15	11	20	15	25	18	28	21	35	26
3/8	14	10	17	13	22	16	27	20	35	26	44	33	50	36	63	46
7/16	22	16	28	20	35	26	44	32	55	41	70	52	80	58	100	75
1/2	33	25	42	31	53	39	67	50	85	63	110	80	120	90	150	115
9/16	48	36	60	45	75	56	95	70	125	90	155	115	175	130	225	160
5/8	67	50	85	62	105	78	135	100	170	125	215	160	240	175	300	225
3/4	120	87	150	110	190	140	240	175	300	225	375	280	425	310	550	400
7/8	190	140	240	175	190	140	240	175	490	360	625	450	700	500	875	650
1	290	210	360	270	290	210	360	270	725	540	925	675	1050	750	1300	975
1-1/8	400	300	510	375	400	300	510	375	900	675	1150	850	1450	1075	1850	1350
1-1/4	570	425	725	530	570	425	725	530	1300	950	1650	1200	2050	1500	2600	1950
1-3/8	750	550	950	700	750	550	950	700	1700	1250	2150	1550	2700	2000	3400	2550
1-1/2	1000	725	1250	925	990	725	1250	930	2250	1650	2850	2100	3600	2650	4550	3350

^aGrade 1 applies for hex cap screws over 152 mm (6-in.) long, and for all other types of bolts and screws of any length.

^bGrade 2 applies for hex cap screws (not hex bolts) up to 152 mm (6 in.) long.

^c"Lubricated" means coated with a lubricant such as engine oil, or fasteners with phosphate and oil coatings.

^d"Dry" means plain or zinc plated without any lubrication.

Torque specifications for certain fasteners may vary from this chart. Do not use any of the bolt torque specifications listed in this chart without first reading the bolt torque information listed on page 20.

Bolt and Cap Screw Torque Values (for Hillco 2000 Leveling Systems Only)

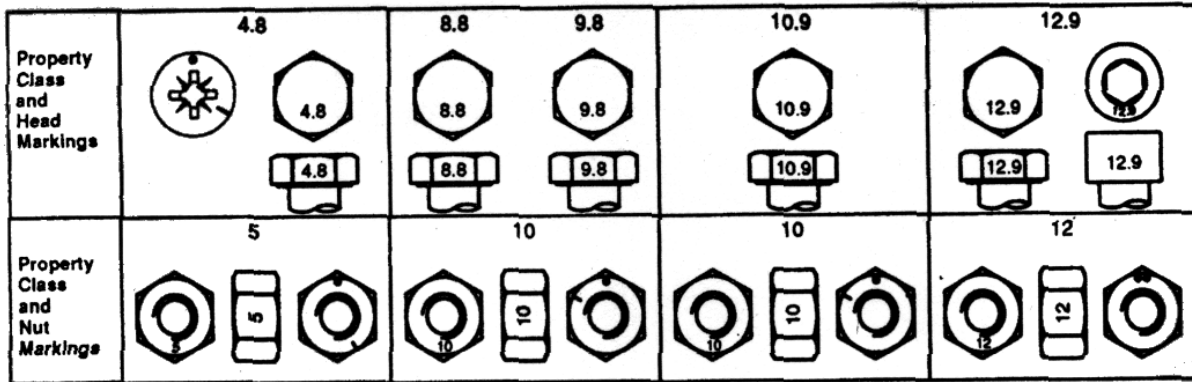

Size	Class 4.8				Class 8.8 or 9.8				Class 10.9				Class 12.9			
	Lubricated ^a		Dry ^b		Lubricated ^b		Dry ^b		Lubricated ^b		Dry ^b		Lubricated ^b		Dry ^b	
	N·m	lb-ft	N·m	lb-ft	N·m	lb-ft	N·m	lb-ft	N·m	lb-ft	N·m	lb-ft	N·m	lb-ft	N·m	lb-ft
M6	4.8	3.5	6	4.5	9	6.5	11	8.5	13	9.5	17	12	15	11.5	19	14.5
M8	12	8.5	15	11	22	16	28	20	32	24	40	30	37	28	47	35
M10	23	17	29	21	43	32	55	40	63	47	80	60	75	55	95	70
M12	40	29	50	37	75	55	95	70	110	80	140	105	130	95	165	120
M14	63	47	80	60	120	88	150	110	175	130	225	165	205	150	260	190
M16	100	73	125	92	190	140	240	175	275	200	350	255	320	240	400	300
M18	135	100	175	125	260	195	330	250	375	275	475	350	440	325	560	410
M20	190	140	240	180	375	275	475	350	530	400	675	500	625	460	800	580
M22	260	190	330	250	510	375	650	475	725	540	925	675	850	625	1075	800
M24	330	250	425	310	650	475	825	600	925	675	1150	850	1075	800	1350	1000
M27	490	360	625	450	950	700	1200	875	1350	1000	1700	1250	1600	1150	2000	1500
M30	675	490	850	625	1300	950	1650	1200	1850	1350	2300	1700	2150	1600	2700	2000
M33	900	675	1150	850	1750	1300	2200	1650	2500	1850	3150	2350	2900	2150	3700	2750
M36	1150	850	1450	1075	2250	1650	2850	2100	3200	2350	4050	3000	3750	2750	4750	3500

^a"Lubricated" means coated with a lubricant such as engine oil, or fasteners with phosphate and oil coatings.

^b"Dry" means plain or zinc plated without any lubrication.

Torque specifications for certain fasteners may vary from this chart. Do not use any of the bolt torque specifications listed in this chart without first reading the bolt torque information listed on page 20.

TIRE INFLATION

Keep the tires properly inflated to the pressure shown in the inflation pressure tables for the front and rear tires. Both under-inflation and over-inflation are detrimental to tire life. Don't re-inflate a tire that has been run flat or when there is obvious or suspected damage to the tire or wheel components. Check the tire pressure weekly or after 50 hours of operation.



WARNING: When inflating tires, use a clip on air chuck and extension hose long enough to allow you to stand to one side and NOT in front or over the tire assembly. Use a safety cage if available.



WARNING: A tire can explode during inflation and cause serious injury or death. Never increase air pressure beyond 35 PSI to seat the bead on the rim. Replace a tire if it has a defect. Replace a wheel rim, which has cracks, wear or severe rust. Make sure that all the air is removed from a tire before removing the tire from the rim. Never use force on an inflated or partially inflated tire. Make sure the tire is correctly seated before inflating.

TIRE PRESSURE CHART

Tire Size	Ply Rating	Tread Type	Tire Pressure	
			PSI	(kPa)
14.9-24	6	R1	20	138
16.9-26	6	R1	22	152
16.9-26	6	R2	22	152
18.4-16.1	6	R1	20	138
18.4-16.1	6	R3	20	138
18.4-26	6	R1	16	110
18.4-26	6	R2	16	110
600/65-R28	L1 147	R1W	13	90
18.4-38	8	R1	24	166
18.4-38	8	R2	24	166
18.4-38	1 Star	R1	24	166
20.8-38	8	R1	22	152
20.8-38	8	R2	22	152
18.4R42	2 Star	R1	28	193
20.8R42	2 Star	R1	24	166
24.5-32	12	R1	28	193
24.5-32	12	R3	24	166
30.5L-32	12	R1	24	166
30.5L-32	12	R2	24	166
30.5L-32	12	R3	24	166
30.5L-32	14	R1	24	166
30.5L-32	16	R3	26	179
35.5L-32	20	R3	28	193.103

Refer to the John Deere 9650 & 9750 operator's manual for information on wheel mounting and hub bolt torque.

SCHEMATICS

MODEL 2970 ELECTRICAL COMPONENT SCHEMATIC

ELECTRICAL COMPONENTS (MODEL 2970)

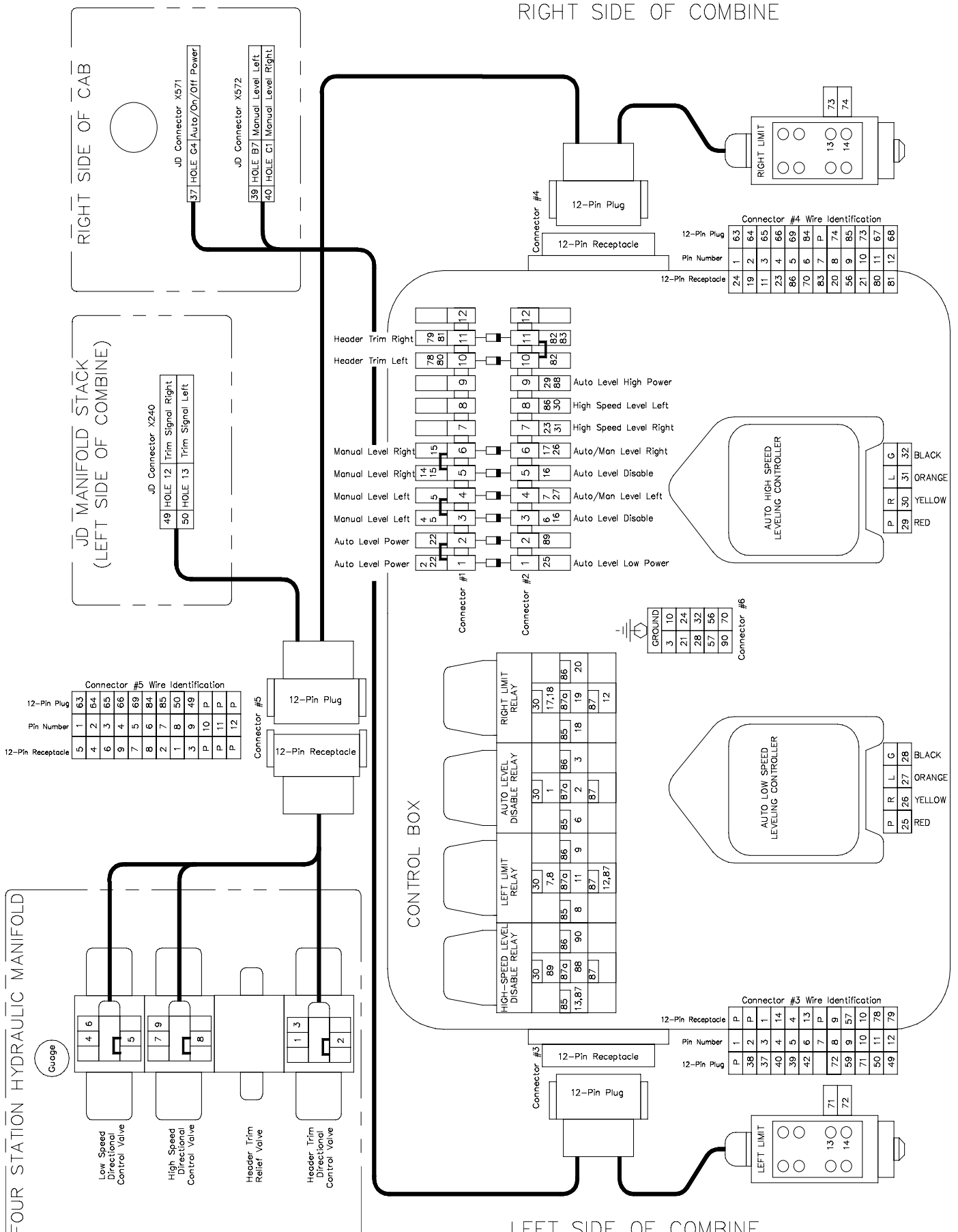

MODEL 2970 ELECTRICAL CIRCUIT SCHEMATIC

JD 2970 Electrical Circuit Schematic

B+(JD Connector X571, Hole G4, Right Side of Cab)

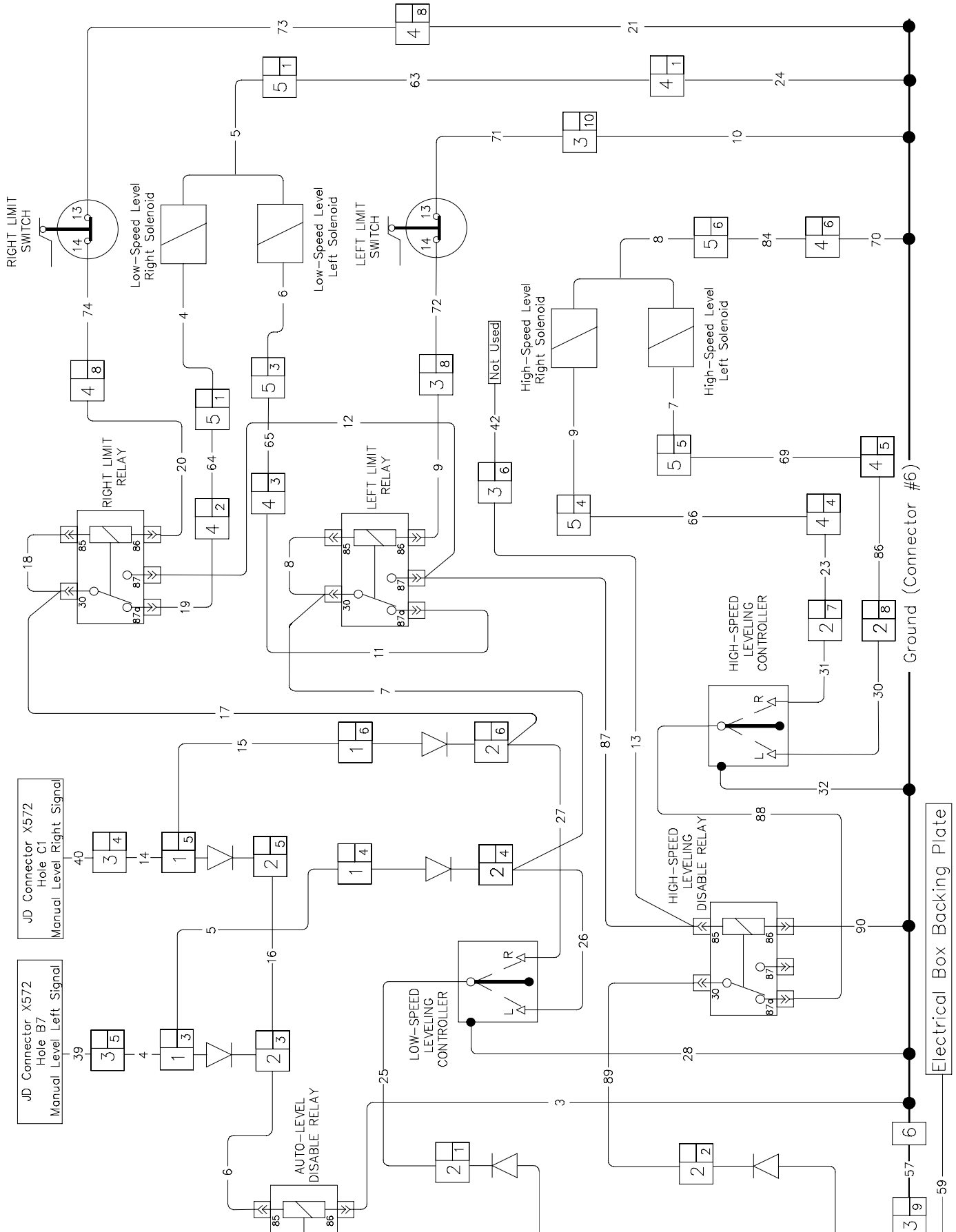

MODEL 2970 HYDRAULIC CIRCUIT SCHEMATIC

JD 2960-70 LEVELING SYSTEM HYDRAULIC SCHEMATIC

